

РАЗМЕРЫ

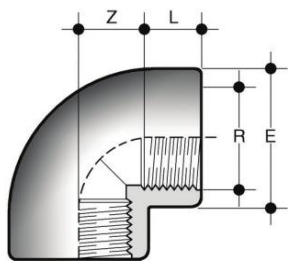

GFV

Отвод 90° с внутренней резьбой с обеих сторон

R	PN	E	L	Z	g	Артикул
3/8"	16	23.5	11.4	13	16	GFV038
1/2"	16	28.5	15	13	24	GFV012
3/4"	16	35	16.3	17	40	GFV034
1"	16	43	19.1	21	72	GFV100
1" 1/4	16	54	21.4	27	130	GFV114
1" 1/2	16	61	21.4	36	185	GFV112
2"	16	76	25.7	46	350	GFV200
2" 1/2	16	91	30.2	55	450	GFV212
3"	16	108	33.3	66	835	GFV300
4"	16	130	39.3	80	1135	GFV400

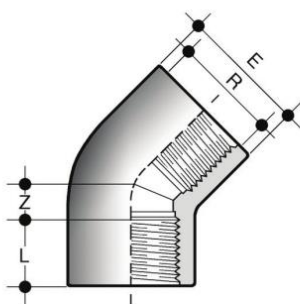

HFV

Отвод 45° с внутренней резьбой с обеих сторон

R	PN	E	L	Z	g	Артикул
1/2"	16	28	15	6.5	18	HFV012
3/4"	16	33	16.3	8	24	HFV034
1"	16	41	19.1	10.5	45	HFV100
1" 1/4	16	50	21.4	15	68	HFV114
1" 1/2	16	64	21.4	21	154	HFV112
2"	16	76	25.7	26	255	HFV200
2" 1/2	16	90	30.2	31	345	HFV212
3"	16	107	33.3	39	625	HFV300

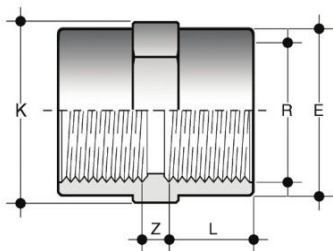

MFV

Муфта соединительная с внутренней резьбой с обеих сторон

R	PN	E	K	L	Z	g	Артикул
3/8"	16	23.5	24	11.4	8	10	MFV038
1/2"	16	28.5	29	15	7	17	MFV012
3/4"	16	35	35	16.3	8.5	26	MFV034
1"	16	43	43	19.1	9	42	MFV100
1" 1/4	16	50	50	21.4	11	53	MFV114
1" 1/2	16	61	61	21.4	17.5	108	MFV112
2"	16	76	76	25.7	19.5	190	MFV200
2" 1/2	16	90	90	30.2	31	275	MFV212
3"	16	108	108	33.3	40.5	500	MFV300
4"	16	130	131	39.3	48.5	665	MFV400

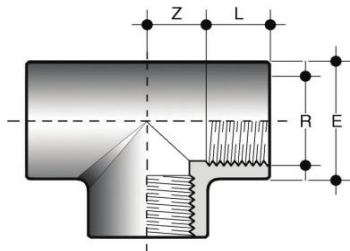

TFV

Тройник равносторонний 90° с внутренней резьбой с обеих сторон

R	PN	E	L	Z	g	Артикул
3/8"	16	23.5	11.4	13	20	TFV038
1/2"	16	28.5	15	13	32	TFV012
3/4"	16	35	16.3	17	52	TFV034
1"	16	43	19.1	21.5	92	TFV100
1" 1/4	16	50	21.4	27	117	TFV114
1" 1/2	16	61	21.4	37	260	TFV112
2"	16	76	25.7	46	465	TFV200
2" 1/2	16	91	30.2	55	640	TFV212
3"	16	109	33.3	66	1135	TFV300
4"	16	133	39.3	83	1710	TFV400

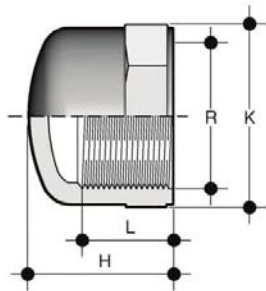

CFV

Заглушка с внутренней резьбой

R	PN	H	K	L	g	Артикул
3/8"	16	19	23	11.4	6	CFV038
1/2"	16	25	28	15	10	CFV012
3/4"	16	27	34	16.3	15	CFV034
1"	16	31	42	19.1	27	CFV100
1" 1/4	16	35	51	21.4	40	CFV114
1" 1/2	16	36	58	21.4	53	CFV112
2"	16	42	71	25.7	85	CFV200
3"	16	55	109	33.3	310	CFV300

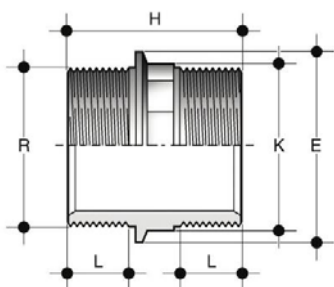

NFV

Ниппель с наружной резьбой

R	PN	E	H	K	L	g	Артикул
3/8"	16	22	33	18	11.4	5	NFV038
1/2"	16	28	41	23	15	10	NFV012
3/4"	16	34	45	28	16.3	16	NFV034
1"	16	40	51	35	19.1	27	NFV100
1" 1/4	16	52	57	44	21.4	40	NFV114
1" 1/2	16	58	58	51	21.4	55	NFV112
2"	16	70	68	64	25.7	93	NFV200

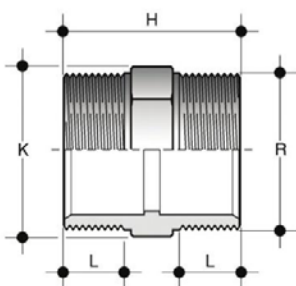

NFV

Ниппель с наружной резьбой

R	PN	E	H	K	L	g	Артикул
*2" 1/2	16	-	78	80	30.2	150	NFV212
*3"	16	-	85	95	33.3	225	NFV300
*4"	16	-	97	120	39	380	NFV400

* Reduced safety factor

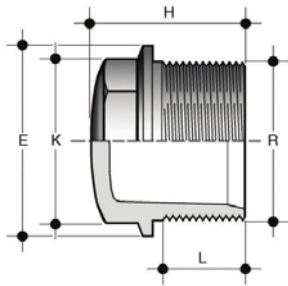

PFV
Заглушка с наружной резьбой

R	PN	E	H	K	L	g	Артикул
3/8"	16	22	22	18	11.4	4	PFV038
1/2"	16	28	26	23	15	8	PFV012
3/4"	16	34	30	28	16.3	11	PFV034
1"	16	40	34	35	19.1	21	PFV100
1" 1/4	16	52	38	44	21.4	30	PFV114
1" 1/2	16	58	40	51	21.4	46	PFV112
2"	16	70	47	64	25.7	74	PFV200

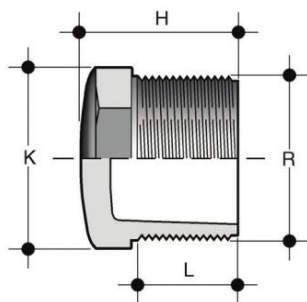

PFV
Заглушка с наружной резьбой

R	PN	E	H	K	L	g	Артикул
2" 1/2	16	-	61	80	30.2	180	PFV212
3"	16	-	71	93	33.3	245	PFV300
4"	16	-	87	118	39.	550	PFV400

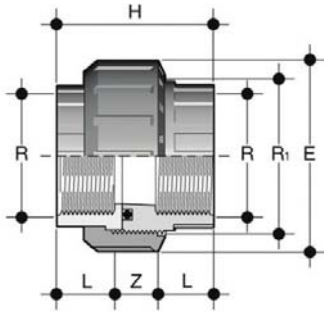

BFV

Муфта разборная (американка) с внутренней резьбой с обеих сторон, уплотнение EPDM или FPM

R	R1	PN	E	H	L	Z	g	Артикул
3/8"	3/4"	16	33	40	11.4	17.2	22	BFV038E
1/2"	1"	16	41	46	15	16	35	BFV012E
3/4"	1" 1/4	16	50	51	16.3	18.4	65	BFV034E
1"	1" 1/2	16	58	57	19.1	18.8	85	BFV100E
1" 1/4	2"	16	72	65	21.4	22.2	145	BFV114E
1" 1/2	2" 1/4	16	79	65	21.4	22.2	180	BFV112E
2"	2" 3/4	16	98	78	25.7	26.6	325	BFV200E

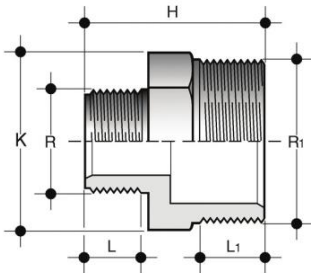

NRFV

Ниппель переходной с наружной резьбой

R1 x R	PN	H	K	L	L1	g	Артикул
3/4" x 1/2"	16	43	30	15	16.3	16	NRFV034012
1" x 3/4"	16	48	36	16.3	19.1	26	NRFV100034
1" 1/4 x 1"	16	54	46	19.1	21.4	46	NRFV114100
1" 1/2 x 1" 1/4	16	57	50	21.4	21.4	60	NRFV112114
2" x 1" 1/2	16	62	65	21.4	25.7	88	NRFV200112
2" 1/2 x 2"	16	73	80	25.7	30.2	140	NRFV212200
3" x 2" 1/2	16	82	95	30.2	33.3	220	NRFV300212
4" x 3"	16	90	120	33.3	39.3	350	NRFV400300

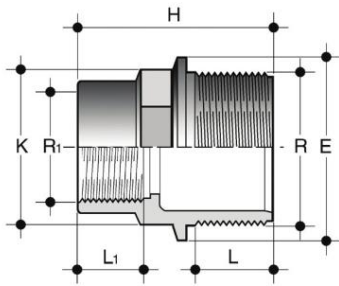

RFV

Переходная втулка с наружной резьбой (R) и внутренней резьбой (R1) (fig. A)

R x R1	PN	E	H	K	L	L1	g	Артикул
1/2" x 3/8"	16	28	35	23	15	11.4	10	RFV012038
3/4" x 3/8"	16	34	36	28	16.3	11.4	12	RFV034038
3/4" x 1/2"	16	34	39	28	16.3	15	15	RFV034012
1" x 3/8"	16	40	41	35	19.1	11.4	20	RFV100038
1" x 1/2"	16	40	44	35	19.1	15	24	RFV100012
1" x 3/4"	16	40	46	35	19.1	16.3	25	RFV100034
1" 1/4 x 1/2"	16	52	48	44	21.4	15	37	RFV114012
1" 1/4 x 3/4"	16	52	49	44	21.4	16.3	37	RFV114034
1" 1/4 x 1"	16	52	52	44	21.4	19.1	40	RFV114100
1" 1/2 x 1/2"	16	58	52	51	21.4	15	46	RFV112012
1" 1/2 x 3/4"	16	58	50	51	21.4	16.3	47	RFV112034
1" 1/2 x 1"	16	58	55	51	21.4	19.1	52	RFV112100
1" 1/2 x 1" 1/4	16	58	57	51	21.4	21.4	54	RFV112114
2" x 3/4"	16	70	60	64	25.7	16.3	80	RFV200034
2" x 1"	16	70	63	64	25.7	19.1	80	RFV200100
2" x 1" 1/4	16	70	65	64	25.7	21.4	85	RFV200114
2" x 1" 1/2	16	70	65	64	25.7	21.4	102	RFV200112

Fig. B

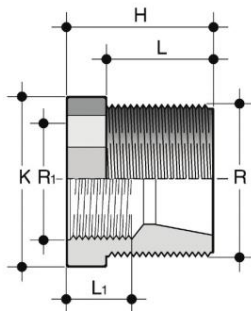

RFV

Переходная втулка с наружной резьбой (R) и внутренней резьбой (R1) (fig. B)

R x R1	PN	E	H	K	L	L1	g	Артикул
2" 1/2 x 2"	16	-	56	80	30.2	25.7	155	RFV212200
3" x 2"	16	-	66	93	33.3	25.7	185	RFV300200
3" x 2" 1/2	16	-	66	93	33.3	30.2	200	RFV300212
4" x 3"	16	-	79	118	39.3	33.3	500	RFV400300

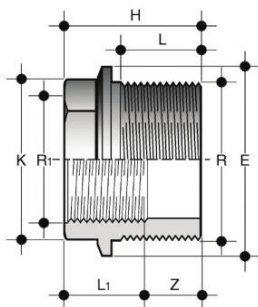

DFV

Переходная втулка с наружной резьбой (R) и внутренней резьбой (R1)

R x R1	PN	E	H	K	L	L	Z	g	Артикул
1/2" x 3/8"	16	28	24	23	11.4	15	12.6	7	DFV012038
3/4" x 1/2"	16	34	26.5	28	15	16.3	11.5	9	DFV034012
1" x 3/4"	16	40	30.5	35	16.3	19.1	14.2	17	DFV100034
1" 1/4 x 1"	16	52	34	44	19.1	21.4	14.9	30	DFV114100
1" 1/2 x 1" 1/4	16	58	35	51	21.4	21.4	13.6	30	DFV112114
2" x 1" 1/2	16	70	40	64	21.4	25.7	18.6	72	DFV200112

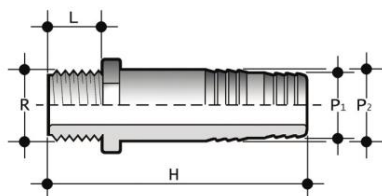

AFV

Шланговый переходник с наружной резьбой

R x P1 x P2	PN	H	L	g	Артикул
1/4" x 12 x 14	16	56	11	7	AFV014012014
3/8" x 16 x 18	16	58	11.4	14	AFV038016018
1/2" x 20 x 22	16	66	15	19	AFV012020022
3/4" x 25 x 27	16	81	16.3	30	AFV034025027
1" x 30 x 32	16	97	19.1	45	AFV100030032
1 1/4" x 40 x 42	16	104	21.4	85	AFV114040042
1 1/2" x 50 x 52	16	111	21.4	120	AFV112050052
2" x 60 x 64	16	123	25.7	180	AFV200060064

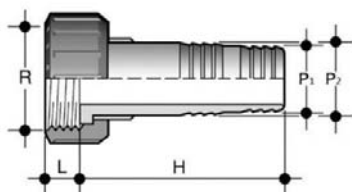

ADV

Шланговый переходник с гайкой, уплотнение EPDM

R x P1 x P2	PN	H	L	g	Артикул
1/2" x 12 x 14	16	56	14	15	ADV012012014
3/4" x 16 x 18	16	60	11.5	24	ADV034016018
1" x 20 x 22	16	67	11	35	ADV100020022
1" 1/4 x 25 x 27	16	81	14	55	ADV114025027
1" 1/2 x 30 x 32	16	97	16	80	ADV112030032
2" x 40 x 42	16	104	18	140	ADV200040042
2" x 50 x 52	16	111	16	180	ADV200050052
2" 1/4 x 50 x 52	16	111	17.5	200	ADV214050052
2" 1/2 x 60 x 64	16	123	19	290	ADV212060064
2" 3/4 x 60 x 64	16	123	20	300	ADV234060064



ОФИЦИАЛЬНЫЙ ПРЕДСТАВИТЕЛЬ FIP В УКРАИНЕ

«ВОДООБРАБОТКА И ОБОРУДОВАНИЕ»

г.Киев, ул.Верховинная, 35

Тел. +380 44 424-90-31

Fax +380 44 424-90-32

info@wte.com.ua

www.pvcpipe.com.ua

Aliaxis
UTILITIES & INDUSTRY

FIP Formatura Iniezione Polimeri

Loc. Pian di Parata, 16015 Casella Genova Italy

Tel. +39 010 9621.1

Fax +39 010 9621.209

info.fip@aliaxis.com

www.fipnet.it

