

# FLS M9.02 FLOW MONITOR & TRANSMITTER



## SAFETY INSTRUCTIONS

### General Statements

- Do not install and service the product without following the Instruction Manual.
- This item is designed to be connected to other instruments which can be hazardous if used improperly. Read and follow all associated instrument manuals before using with it.
- Product installation and wiring connections should only be performed by qualified staff.
- Do not modify product construction.

### Installation and Commissioning Statements

- Remove power to the instrument before wiring input and output connections.
- Do not exceed maximum specifications using the instrument.
- To clean the unit, use only chemical compatible products.

## PACKING LIST

Please verify that the product is complete and without any damage.

The following items must be included:

- M9.02 Flow Monitor
- Instruction Manual for M9.02 Flow Monitor
- Instruction Manual for F3.00 Flow Sensor (only for M9.02.XX Field Mount Flow Monitor).

## DESCRIPTION

The new FLS M9.02 is a powerful flow monitor designed to convert the frequency signal of FLS flow sensors into a flow rate. M9.02 is equipped with a wide full graphic display 4" which shows measured values clearly and a lot of other useful information. Moreover, due to a multicolor display plus a powerful backlight, measurement status can be determined easily from afar also. A tutorial software guarantees a mistake-proof and fast set up of every parameters. Calibration can be performed just fixing installation features or using a reference value through a new "in-line calibration". A 4-20mA output is available to remote flow rate to a external device. A proper combination of digital outputs allows customized setups for any process to be controlled.

## CONNECTIONS TO INSTRUMENTS

	F3.00	F3.20	F6.30	F3.10	F3.05	F6.60	F6.61	F111
M9.02	x	x	-	X	-	X	X	X

	ULF	F3.80	pH/ ORP200	pH/ ORP400	pH/ ORP600	pH/ ORP800	C150/ 200	C100/ C300	C6.30
M9.02	X	X	-	-	-	-	-	-	-

## TECHNICAL DATA

### General

- Associated sensors: FLS hall effect flow sensors with frequency output or FLS F6.60 flow magmeter family
- Materials:
  - Case: ABS
  - Display window: PC
  - Panel & Wall gasket: silicone rubber
  - Keypad: 5-button silicone rubber
- Display:
  - LC full graphic display
  - Backlight version: 3-colors
  - Backlight activation: User adjustable with 5 levels of timing
  - Update rate: 1 second
  - Enclosure: IP65 front
- Flow input range (frequency): 0÷1500Hz
- Flow input accuracy (frequency): 0,5%

## Electrical

- Supply Voltage: 12 to 24 VDC  $\pm$  10% regulated
- FLS hall effect flow Sensor power:
  - 5 VDC @ < 20 mA
  - Optically isolated from current loop
  - Short circuit protected
- 1 x Current output:
  - 4-20 mA, isolated, fully adjustable and reversible
  - Max loop impedance: 800  $\Omega$  @ 24 VDC - 250  $\Omega$  @ 12 VDC
- 2 x Solid State Relay output:
  - User selectable as MIN alarm, MAX alarm, Pulse Out, Window IN Alarm, Window OUT Alarm, Off
  - Optically isolated, 50 mA MAX sink, 24 VDC MAX pull-up voltage
  - Max pulse/min: 300
  - Hysteresis: User selectable
- 1 x Relay output:
  - User selectable as MIN alarm, MAX alarm, Pulse Out, Window IN Alarm, Window OUT Alarm, Off
  - Mechanical SPDT contact
  - Expected mechanical life (min. operations):  $10^7$
  - Expected electrical life (min. operations):  $10^5$  N.O./N.C. switching capacity 5A/240VAC
  - Max pulse/min: 60
  - Hysteresis: User selectable

## Environmental

- Operating temperature: -20 to +70°C (-4 to 158°F)
- Storage temperature: -30 to +80°C (-22 to 176°F)
- Relative humidity: 0 to 95% not condensing

## Standards & Approvals

- Manufactured under ISO 9001
- Manufactured under ISO 14001
- CE
- RoHS Compliant
- EAC

# DIMENSIONS

## COMPACT MOUNTING

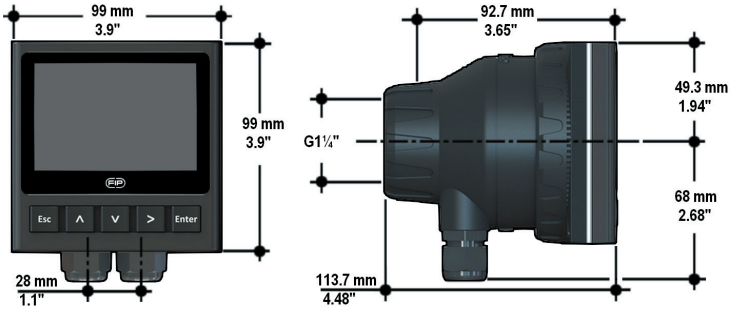

## PANEL MOUNTING

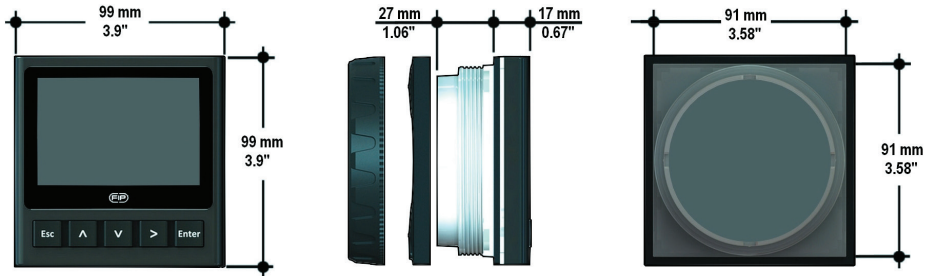

## WALL MOUNTING

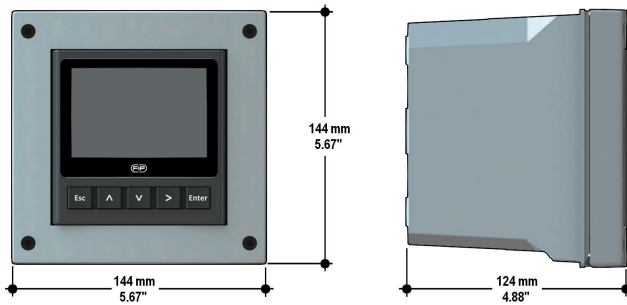

# INSTALLATION

## Mechanical installation

The flow monitor & transmitter is available just in one packaging for compact field version, panel or wall installation. The compact field version is mounted on top of the sensor using the compact mounting kit (F6.KC1), the panel version is installed using the panel mounting kit (M9.LN1), while the wall mounting version is got fixing the panel mounting version on the wall mounting kit (M9.KWX). The mounting kits can be ordered directly connected to the monitor or separately and then simply installed on it.

## Panel installation

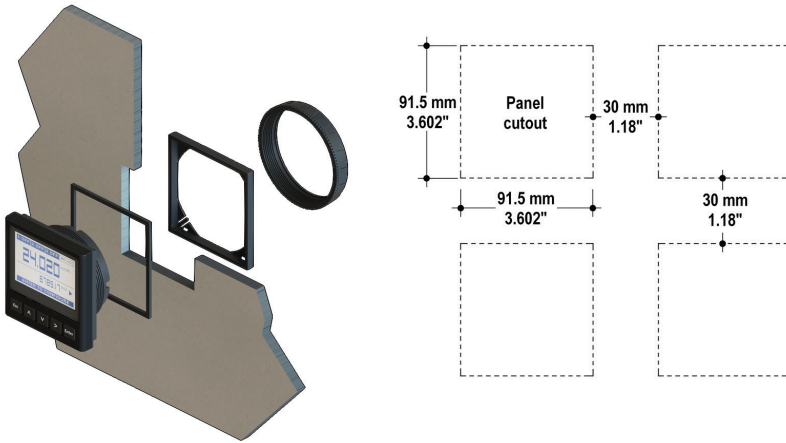

Fix instrument on the panel tightening by hand plastic nut (M9.LN1).

## Wall installation

Use the panel mounting kit (M9.LN1) to fix the M9.02 on the dedicated frontal cutout of the wall mounting kit (M9.KWX).

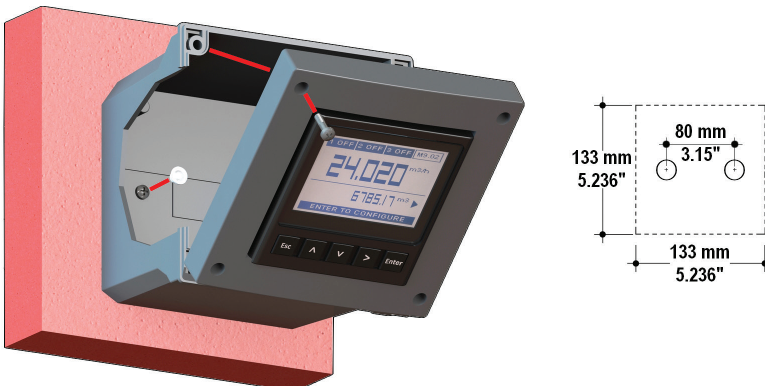

Tighten front screws of box and waterproof connectors of cables, internally mount caps on screw sites to get a IP65 watertight installation.

## Compact installation

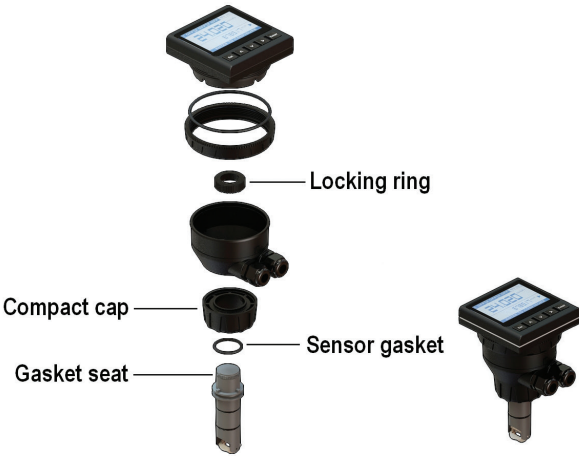

The compact mounting kit (F6.KC1) includes the compact plastic adapter with gasket for IP65 watertight installation, sensor gasket, the compact cap and the locking ring.

- Lubricate the sensor gasket with silicone lubricant and mount it on the proper seat.
- Add the compact cap to the sensor and insert the sensor into the plastic adapter making sure the alignment tabs are seated in the fitting notches.
- Lock the sensor to the adapter: screw completely the locking ring.
- Tighten plastic nut to fix monitor on plastic adapter.

## WIRING

### General recommendation



Always ensure the power supply is switched off before working on the device. Make wiring connections according to wiring diagrams.

- Terminals accept 26 to 12 AWG (0.08 to 2.5 mm<sup>2</sup>)
- Strip around 10 mm (0.4") of insulation from the wire tips and tin bare ends to avoid fraying.
- Ferrules are suggested when connecting more than one wire to a single terminal.
- Remove the upper part of the terminals for an easy cabling.
- Insert wire tip or ferrule completely into the terminal and fix with the screw until finger tight.
- Do not route the sensor, DC power, or 4-20mA cables in conduit containing AC power wiring. Electrical noise may interfere with sensor signal.
- Routing the sensor cable in grounded metal conduit can help prevent electrical noise and mechanical damage.
- Seal the cable entry points to prevent moisture damage.

## Compact or Wall Installation

Pull the electrical cables through liquid tight connectors.

Use electrical cables with the proper external diameter for the liquid tight connector.

PG11/PG9: external diameter between 2-7 mm (0.079-0.276")

## REAR TERMINAL VIEW

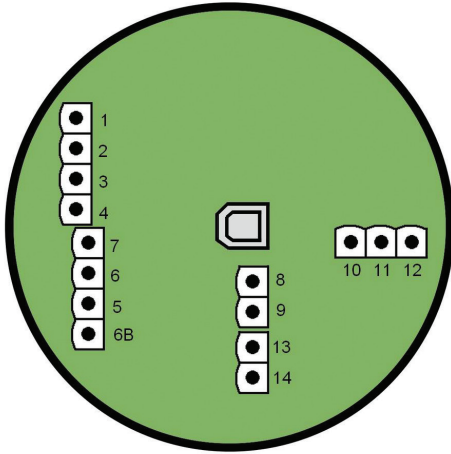

1	+VDC
2	+LOOP
3	-LOOP
4	-VDC

**Power Supply**

7	V+
6	FREQ IN
5	GND
6B	DIR

**Flow Sensor**

8	NO
9	COM

**SSR1**

10	NC
11	COM
12	NO

**RELAY**

13	NO
14	COM

**SSR2**

Refer to dedicated sensor manual for its wiring.

## POWER/LOOP WIRING DIAGRAM

Stand-alone application,  
no current loop used

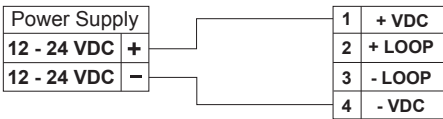

Connection to a PLC with built-in  
power supply (3 wire connection)

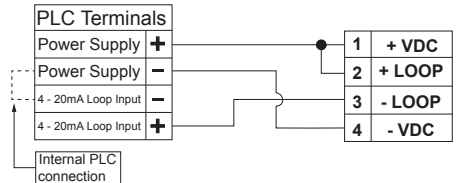

Connection to a PLC/Instrument with ONE separate power supply

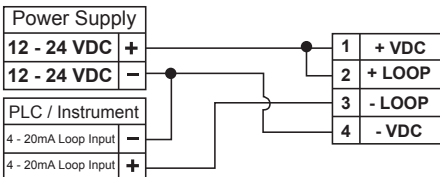

OR

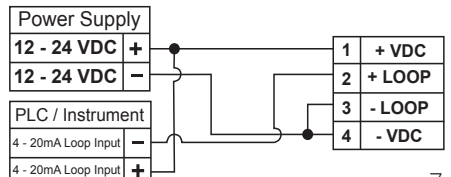

## Connection to a PLC / Instrument with TWO separate power supplies

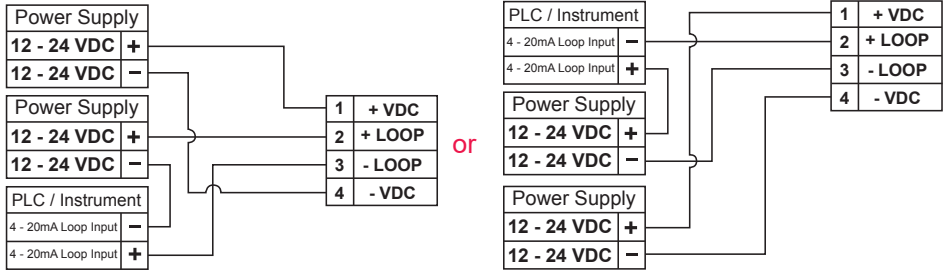

## USB PORT

A USB port (type B) is available on the M9.02 PCB.

The USB connection allows the updating of device software.

To update the software you need: USB cable (M9.KUSB), the interface software "FLS Calibration System" and the new updating software for M9.02 which are both downloadable from [www.flsnet.it](http://www.flsnet.it) freely on product page.

## SOLID-STATE RELAY WIRING DIAGRAM (FOR SSR1 AND SSR2)

Connection to a PLC with NPN input

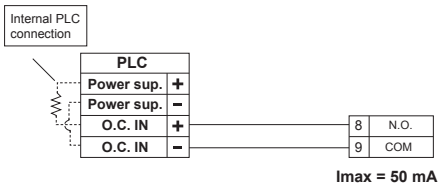

Connection to a PLC with PNP input

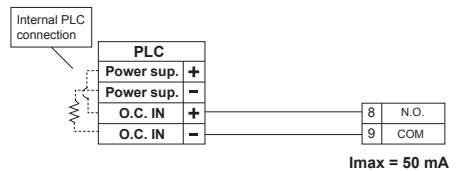

Connection to a PLC / Instrument digital input with separate Power Supply

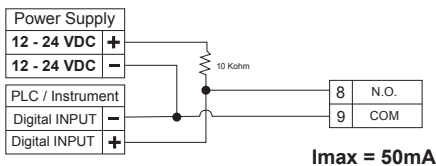

Connection to a PLC / Instrument digital input for Voltage Free Contacts (REED)

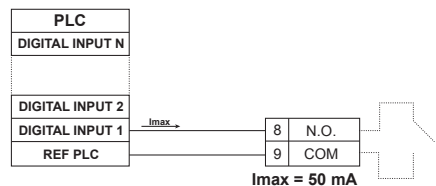



## Connection to an User

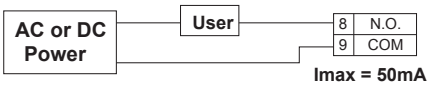

## Connection to an User

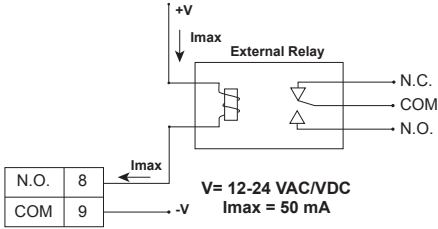

The alarm is off during normal operation and goes ON according to Relay setting.  
If  $I_{max} > 50 \text{ mA}$  use external Relay

## Connection to other FLS Instruments



## RELAY WIRING DIAGRAM

The alarm is OFF during normal operation and goes ON according to Relay settings

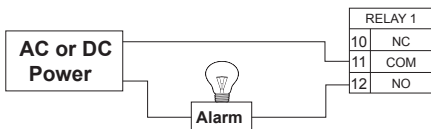

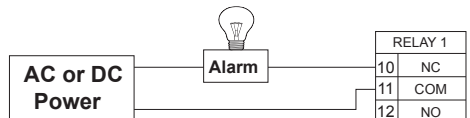

The alarm is ON during normal operation and goes OFF according to Relay settings

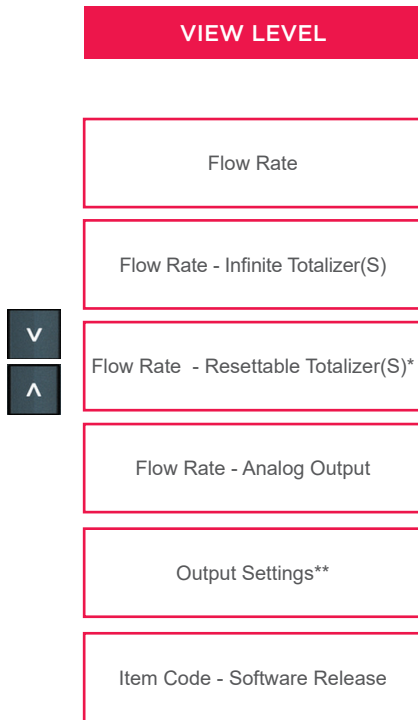

# OPERATIONAL OVERVIEW

The M9.02 flow monitor and transmitter features a full graphic display and a five-button keypad for system set-up, calibration and operation. Full graphic display has a white backlight during standard conditions, a red backlight in case a set alarm is activated (MAX, MIN, WINDOW IN, WINDOW OUT MODE: always with priority), a green backlight in case a external device control is activated (PULSE MODE).



\*Resettable totalizers can be reset using  on view level

\*\* Use  for more info about Outputs

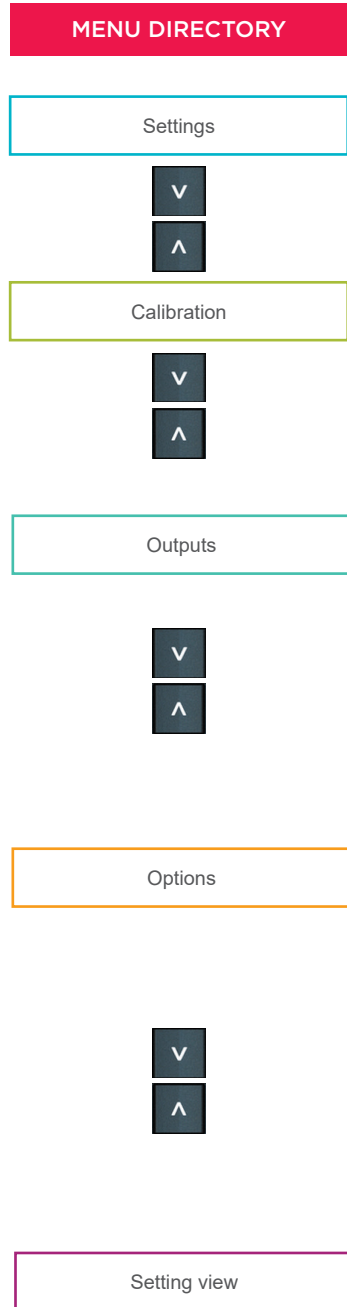

## MENU LEVEL

▼	Installation Data
▲	Flow Unit
	Volume Unit
▼	Correction Factor
▲	Auto Calibration
	1 SSR
▼	2 SSR
▲	3 RELAY
	4 - 20 mA
	Test Output
	Language
	Filter
	Backlight
	Flow Rate Decimal Point
▼	Password***
▲	Asec
	Bi-Directional
	Default Data
	Custom Calibration
	Contrast
	Outputs Activation
	Upgrade Firmware
	Sensor Type Pipe Parameter Pipe Diameter Internal Diameter K-factor****

\*\*\* password combination:



\*\*\*\* in case of installation on PVCC pipes, the K factor values are referred to T fittings type TFIFXXDC/BC

## EDIT LEVEL

### PUSH BUTTON



to modify an item



to scroll right



to return to Menu without saving





to save new settings

# OUTPUT MODE

The M9.02 flow monitor and transmitter features 2 solid state relays and 1 mechanical relay in addition to an analog output 4-20mA.

## PROCEDURE FOR OUTPUTS SETTING

- go to the "Options" menu
- enter into the "Outputs activation" sub menu
- enable output(s)
- go to the "Outputs" menu
- set the operating mode for each enabled output

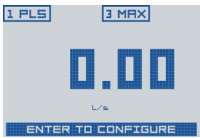
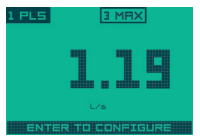
			
<p>Monitor without digital output activated</p>	<p>In case a digital output is enabled, a icon will appear</p>	<p>In case a digital output is set, icon reports the operating mode</p>	<p>In case set digital output is activated, the icon will turn to black (display turns green in case output is set to manage an external device, red to indicate a activated output as alarm)</p>

Digital outputs can be set in the following way:

### MIN MODE (icon reports MIN)

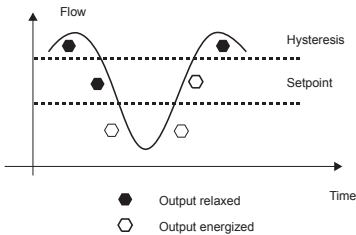

### MAX MODE (icon reports MAX)

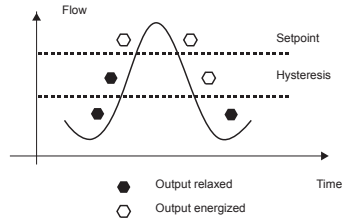

### WINDOW IN MODE (icon reports WIN)

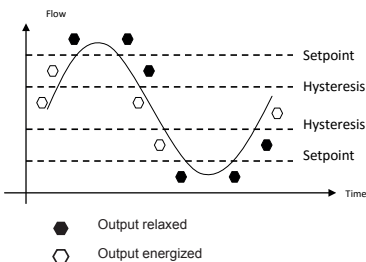

### WINDOW OUT MODE (icon reports WOT)

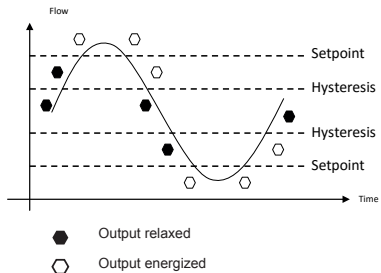

## PULSE MODE (icon reports PLS)

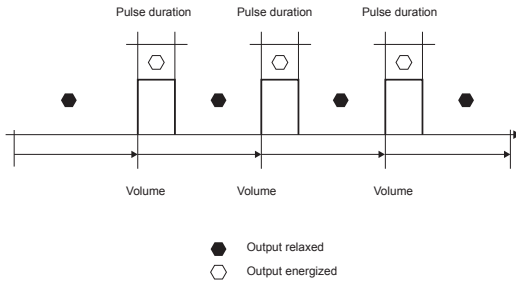

In case the bidirectional function is activated, ICONS will report also a reference to the flow direction:

- + for main direction (e.g. MAX +)
- for opposite direction.(e.g. MAX -)

## SOFTWARE UPDATING

In order to update the Instrument Software with a New Firmware Release follow the suggested procedures:

### TO UPDATE INSTALLED UNITS

- Download the interface software "FLS Calibration System" and the Updated Software on [www.flsnet.it](http://www.flsnet.it)
- Launch the software "FLS Calibration System" on the laptop
- Select OPTION and then UPGRADE FIRMWARE
- Confirm the "Firmware Upgrade" procedure by ENTER
- Connect M9.02 to the laptop by the USB cable
- Select the item (M9.XX) which appears on the "Navigation" area on the "FLS Calibration System" software
- Confirm FW UPGRADE and select the Updated Software

NOTE: At the end of the procedure restart the instruments in order to refresh M9.02 software (It takes 90 seconds to refresh the SW. Please do not interrupt the restarting process).

### TO UPDATE NEW UNITS

- Download the interface software "FLS Calibration System" and the updated software on [www.flsnet.it](http://www.flsnet.it).
- Launch the software "FLS Calibration System" on the laptop
- Push together ENTER and ESC powering the monitor
- Connect M9.02 to the laptop by the USB cable
- Select the item (M9.XX) which appears on the "Navigation" area on the software "FLS Calibration System"
- Confirm FW UPGRADE and select the Updated Software

NOTE: At the end of the procedure restart the instruments in order to refresh M9.02 software (It takes 90 seconds to refresh the SW. Please do not interrupt the restarting process).

# ORDERING DATA

Part No.	Description /Name	Power supply	Wire power Technology	Sensor Input	Output
M9.02.P1	Panel mount Flow Monitor	12 - 24 VDC	3/4 wire	Flow (Frequency)	1*(4-20mA), 2*(S.S.R.), 1*(mech. relay)
M9.02.W1	Wall mount Flow Monitor	12 - 24 VDC	3/4 wire	Flow (Frequency)	1*(4-20mA), 2*(S.S.R.), 1*(mech. relay)
M9.02.W2	Wall mount Flow Monitor	110 - 230 VAC	3/4 wire	Flow (Frequency)	1*(4-20mA), 2*(S.S.R.), 1*(mech. relay)
M9.02.01	Field mount Flow Monitor	12 - 24 VDC	3/4 wire	Flow (Frequency)	1*(4-20mA), 2*(S.S.R.), 1*(mech. relay)
M9.02.02	Field mount Flow Monitor	12 - 24 VDC	3/4 wire	Flow (Frequency)	1*(4-20mA), 2*(S.S.R.), 1*(mech. relay)
M9.02.03	Field mount Flow Monitor	12 - 24 VDC	3/4 wire	Flow (Frequency)	1*(4-20mA), 2*(S.S.R.), 1*(mech. relay)
M9.02.04	Field mount Flow Monitor	12 - 24 VDC	3/4 wire	Flow (Frequency)	1*(4-20mA), 2*(S.S.R.), 1*(mech. relay)
M9.02.05	Field mount Flow Monitor	12 - 24 VDC	3/4 wire	Flow (Frequency)	1*(4-20mA), 2*(S.S.R.), 1*(mech. relay)
M9.02.05	Field mount Flow Monitor	12 - 24 VDC	3/4 wire	Flow (Frequency)	1*(4-20mA), 2*(S.S.R.), 1*(mech. relay)
M9.02.06	Field mount Flow Monitor	12 - 24 VDC	3/4 wire	Flow (Frequency)	1*(4-20mA), 2*(S.S.R.), 1*(mech. relay)
M9.02.07	Field mount Flow Monitor	12 - 24 VDC	3/4 wire	Flow (Frequency)	1*(4-20mA), 2*(S.S.R.), 1*(mech. relay)

Part No.	Description /Name	Power supply	Wire power Technology	Sensor Input	Output
M9.02.08	Field mount Flow Monitor	12 - 24 VDC	3/4 wire	Flow (Frequency)	1*(4-20mA), 2*(S.S.R.), 1*(mech. relay)
M9.02.09	Field mount Flow Monitor	12 - 24 VDC	3/4 wire	Flow (Frequency)	1*(4-20mA), 2*(S.S.R.), 1*(mech. relay)
M9.02.10	Field mount Flow Monitor	12 - 24 VDC	3/4 wire	Flow (Frequency)	1*(4-20mA), 2*(S.S.R.), 1*(mech. relay)
M9.02.11	Field mount Flow Monitor	12 - 24 VDC	3/4 wire	Flow (Frequency)	1*(4-20mA), 2*(S.S.R.), 1*(mech. relay)
M9.02.12	Field mount Flow Monitor	12 - 24 VDC	3/4 wire	Flow (Frequency)	1*(4-20mA), 2*(S.S.R.), 1*(mech. relay)
M9.02.13	Field mount Flow Monitor	12 - 24 VDC	3/4 wire	Flow (Frequency)	1*(4-20mA), 2*(S.S.R.), 1*(mech. relay)
M9.02.14	Field mount Flow Monitor	12 - 24 VDC	3/4 wire	Flow (Frequency)	1*(4-20mA), 2*(S.S.R.), 1*(mech. relay)
M9.02.15	Field mount Flow Monitor	12 - 24 VDC	3/4 wire	Flow (Frequency)	1*(4-20mA), 2*(S.S.R.), 1*(mech. relay)
M9.02.16	Field mount Flow Monitor	12 - 24 VDC	3/4 wire	Flow (Frequency)	1*(4-20mA), 2*(S.S.R.), 1*(mech. relay)

## ACCESSORIES

Part No.	Name	Description
F6.KC1	Compact mounting kit	Plastic adapter with compact cap and locking nut (for M9.02 only)
M9.KW1	Wall mounting kit	144x144mm plastic box for wall installation of all panel mount monitors
M9.KW2	Wall mounting kit with power supply	144x144mm plastic box and 110/230VAC to 24 VDC power supply for wall installation of all panel mount monitors
M9.KUSB	USB cable for device interfacing	USB cable dedicated to FLS products, 1,5 meter long

## SPARE PARTS

Part No.	Name	Description
M9.SP4.1	PG 11	PG 11 complete cable gland (2 o-rings and cap)
M9.LN1	Locking nut	Plastic locking nut for M9.02

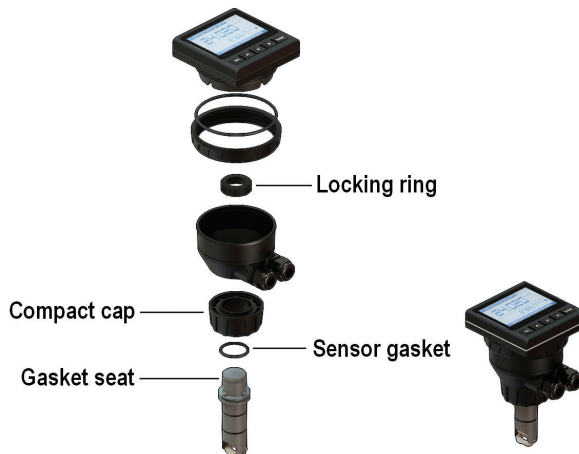

FIP - Formatura Iniezione Polimeri S.p.A.

Loc. Pian di Parata  
16015 Casella  
Genova - Italy  
Tel. +39 010 96211  
Fax +39 010 9621209  
[www.flsnet.it](http://www.flsnet.it)